

FS-C5020N and FS-C5030N

Product Guide



 **KYOCERA**



*FS-C5020N and FS-C5030N Product Guide
Published April 2005*

© 2005 Kyocera Mita Australia Pty Ltd
Specifications subject to change without notice.

Table of Contents

Introduction	5
System Overview	6
Just the Facts	9
Key Features	13
Technology	19
Productivity	21
Optional Accessories	23
Controller	27
KX Driver	29
Print System Utilities	39
Counters, Yields, and Volume Rating	47
Trademarks and Disclaimers	49
Index	51

This page intentionally blank

FS-C5020N and FS-C5030N Product Guide

Introduction

Building on the success of the FS-C5016N, Kyocera adds two new high quality, highly reliable, fully functional, Full-Color printers targeting the demands for workgroup corporate color printing. Meet the all new FS-C5020N and the FS-C5030N Print Systems.



Serious Business - Serious Color

These affordable, 16 and 24ppm full-color tandem process ECOSYS™ workgroup printers are capable of imaging at 600 dpi for crisp colorful A4 size corporate documents - *for about 12 cents a page in full-color*. In addition, the fast PowerPC 750CXr and 750FX CPUs, process documents quickly for maximum productivity and minimum wait time. Plus, standard 10/100BaseTX and convenient KX driver installation, makes the FS-C5020N and FS-C5030N an easy addition to corporate networks

System Overview

With the transition of distributed documents from monochrome to color continuing to expand at a fast pace, colour printers have become increasingly attractive to a broader array of decision makers in the corporate world - in some cases, even taking the place of older monochrome models. And with color presentations and bulletins continuing to become standard practice, the market is primed to accept products like the FS-C5020N and FS-C5030N Full-Color Tandem Process Printers. The award-winning FS-C5016N was designed to do just that. With the release of the FS-C5020 and FS-C5030N, Kyocera plans to build upon that success.

Now add the fact that ***Kyocera has a printer at about twelve cents per page full-color*** and you've got a dynamic printer solution that will grab everyone's attention! Take a look!

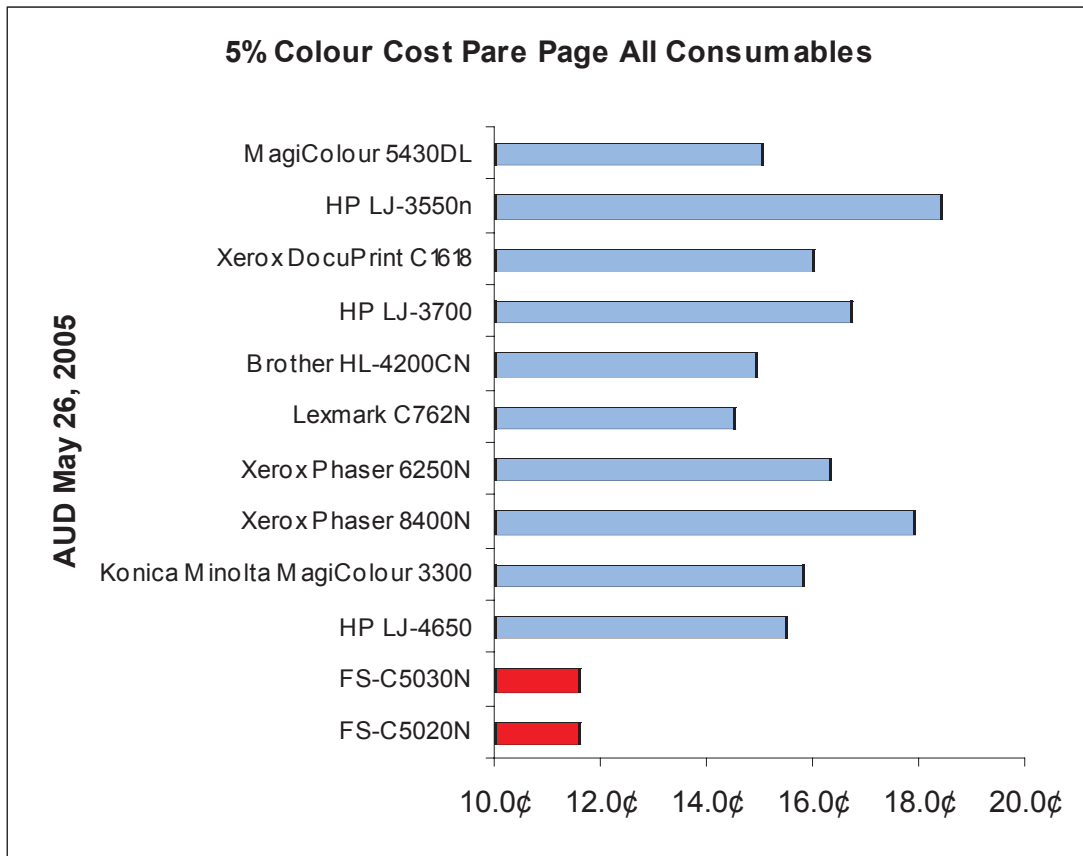

No other competitor comes close to the cost savings these compact printers produce over their lifetime. No other printer on the market will positively impact a company's bottom line like the FS-C5020N and the FS-C5030N.

System Overview

Developed with ECOSYS technology and color printing needs in mind: The FS-C5020N and FS-C5030N have a small footprint, fast colour speed, and low CPP. The FS-C5020/30 are designed to meet the colour output demands in today's office environment. Consider the following features:

- ◆ Fast Monochrome and Full-Colour Printing
 - ◆ FS-C5020N: 16ppm
 - ◆ FS-C5030N: 24ppm
- ◆ Standard 10/100BaseTX network interface
- ◆ Ability to image onto paper sizes ranging from A5 to A4 and on paper weights ranging from 60gsm up to 200gsm - from the 100 Sheet Multi-Purpose Paper Tray
- ◆ High performance PowerPC CPUs for faster processing
 - ◆ FS-C5020N: PowerPC750CXr
 - ◆ FS-C5030N: PowerPC750FX
- ◆ High-Yield 200K Maintenance Kits
- ◆ High Print Quality of 600DPI with 256 gradation levels along with Kyocera's Multi-Bit Technology
- ◆ Optional 20GB Hard Disk Drive for faster document processing, and storage of fonts, PRESCRIBE forms, and frequently used documents
- ◆ Low Cost Per Print (CPP) for both Colour and Monochrome output providing a low TCO

Collectively, these capabilities make the FS-C5020N and FS-C5030N affordable, easy to use, efficient, and productive workgroup Colour Print Systems. Let's take a closer look



This page intentionally blank

Just the Facts

Technology

- ◆ **Type:** Desktop Full-Colour/Monochrome Printers
- ◆ **Imaging System:** 4 Drum Tandem
- ◆ **Colour Technology:** Advanced Beam Array
- ◆ **Primary Transfer:** Intermediate Transfer Belt
- ◆ **Secondary Transfer:** Roller
- ◆ **Fusing:** Oil-Less Heat/Pressure
- ◆ **Controller:** PowerPC
 - ◆ FS-C5020N: PowerPC750Cxr
 - ◆ FS-C5030N: PowerPC750FX
- ◆ **Print Resolution:** Multi Bit 600 DPI (2 and 4 bit modes)
- ◆ **Gradation Levels:** 256
- ◆ **Service:** 200K MK-510 or MK-520 Maintenance Kit
Includes: Drum, Developer Kit, Transfer Unit, Feed Unit, Fuser Kit, Two Ozone Filters, Roller Feed Set
- ◆ **C, M, Y, K Toner Cartridge Yield:** 8K
- ◆ **Toner Type:** Polymerized
- ◆ **HDD:** Optional 20GB
- ◆ **Maximum Monthly Volume:**
 - ◆ FS-C5020N: 85K
 - ◆ FS-C5030N: 100K

Memory Management

- ◆ Optional 20GB HDD
- ◆ 128MB RAM (1024MB Max with 100 pin DDR DIMMs)
- ◆ One Compact Flash Card Slot
- ◆ One KUIO-LV Slot

Speeds

- ◆ Warm up: FS-C5020N: 80 Seconds, FS-C5030N: 80 Seconds

FS-C5020N		FS-C5030N	
FPOT Color/Mono	16 Sec	FPOT Color/Mono	12 Sec
A4 (Color/Mono)	16/16 PPM	A4 (Color/Mono)	24/24 PPM
Legal (Color/Mono)	14/14 PPM	Legal (Color/Mono)	21/21 PPM
Thick (Color/Mono)	7/7 PPM	Thick (Color/Mono)	12/12 PPM
OHP (Color/Mono)	7/7 PPM	OHP (Color/Mono)	12/12 PPM
Duplex (A4)	16 PPM	Duplex (A4)	24 PPM
Duplex A4 Efficiency	100%	Duplex A4 Efficiency	100%
Duplex (legal)	14 PPM	Duplex (legal)	20 PPM
Duplex Legal Efficiency	100%	Duplex Legal Efficiency	95%

Just the Facts

Paper Handling

- ◆ **Std. 500 Sheet Paper Drawer**

Paper Size: A4, A5, B5, Letter, Legal.
Custom: 148mm x 210mm - 216mm x 356mm
Paper Weights: 60gsm to 105gsm
Paper Types: Plain, Recycled, Thick

- ◆ **Std. 100 Sheet Multi-Purpose Tray**

Paper Size: A4, A5, B5, Letter, Legal,
Custom: 70mm x 148mm - 216mm x 297mm
Paper Weights: 60gsm to 200gsm
Paper Types: Plain, Recycled, Transparencies, Adhesive-Backed
Labels, Envelopes, Cardstock, PostCards

- ◆ **Std./Max. Paper Supply:** 600/2,100 Sheets

- ◆ **Std./Max. Paper Sources:** 2/5 Drawers

- ◆ **Opt. 500 Sheet Paper Drawer (Up to 3) (PF-60)**

Paper Size: A4, A5, B5, Letter, Legal, Custom
Paper Weights: 60gsm to 105gsm

- ◆ **Opt. Automatic Duplex Unit (DU-301)**

Paper Weights: 60gsm to 105gsm

- ◆ **Opt. Envelope Feeder (EF-60)**

Up to 40mm or 1.5" Height Capacity

- ◆ **Face-Up Tray: (PT-300)**

250 sheet for printer
100 sheets for Duplexer (DU-301)

Connectivity & Interface

- ◆ Std. 10/100 BaseTX
- ◆ Std. Hi-Speed USB 2.0
- ◆ Std. Bi-Directional Parallel (IEEE 1284 Nibble/ECP mode)
- ◆ Std. KUIO-LV (one slot for HDD or one of the following:)
 - ◆ Opt. IC159-WLAN IEEE 802.11b (Wireless)
 - ◆ Opt. IB-11 Serial

Page Description Languages

- ◆ KPDL3 (Postscript 3 Emulation)
- ◆ PCL 6 (PCL 5c/PCL XL)
- ◆ PRESCRIBE

Fonts

- ◆ 136 KPDL PostScript
- ◆ 80 PCL 5c/PCL XL Outlines
- ◆ 1 Bitmap

Just the Facts

Compatibility

- ◆ Windows OS: 9x/Me/2000/XP
- ◆ Novell: Novell Netware 3.x/4.x/5.x/6.x
- ◆ Mac OS: 8.x/9.x/10.x
- ◆ UNIX: Sun OS 4.1.x; Solaris 2.x; AIX; HP-UX (LPR)

Supported Protocols

- ◆ TCP/IP
- ◆ IPX.SPX
- ◆ AppleTalk
- ◆ NetBEUI

Driver

- ◆ KX Driver for Windows
- ◆ PPD for Mac
- ◆ PPD for CUPS (Linux/Unix)
- ◆ Certified Uni Driver

KM-NET Solution

- ◆ KM-NET Viewer Web Edition
- ◆ KM-NET Viewer
- ◆ KM-NET Client
- ◆ KM-NET PDF Direct Print
- ◆ Network Advanced Set-Up Utilities
- ◆ PRESCRIBE Utilities

Enhanced Multiple Printing System (eMPS)

- ◆ Quick Copy*
- ◆ Proof and Hold
- ◆ Private Print
- ◆ Job Storage*
- ◆ Virtual MailBox*

*(requires HDD)

Yields

- ◆ Starter Toner: 4K for C, M, Y, K
- ◆ C, M, Y, K Toner: 8K
- ◆ Maintenance Kit: 200K

Just the Facts

Other

- ◆ W x D x H: 345mm x 470mm x 385mm
- ◆ Weight:
 - FS-C5020N Weight: 22kg
 - FS-C5030N Weight: 23kg
- ◆ Power Requirements: 220-240 V, 50/60 Hz
- ◆ Energy Star Compliant
- ◆ Operating Noise Level: 55 dB



Options

- ◆ Memory: 64, 128, 256, 512MB x 2 slots (DDR DIMMs)
- ◆ Compact Flash Card (1 slot)
- ◆ 20GB HDD
- ◆ Interface Boards: IB-11, IB-20, IC159-WLAN
- ◆ Add up to three 500 Sheet Paper Drawers (PF-60)
- ◆ Automatic Duplex Unit (DU-301)
- ◆ Envelope Feeder (EF-60)
- ◆ Face-Up Tray (PT-300) (FS-C5020N)
- ◆ Face-Up Tray (PT-301) (FS-C5020N)



FS-C5020N shown with optional Duplexer and Paper Drawers.

FS-C5020N and FS-C5030N Key Features

A tandem colour solution combining a small footprint, image quality, and speed, with an economical price is a winning formula for success in the office environment. Kyocera has accomplished this enviable combination with the FS-C5020N and FS-C5030N Colour Print Systems.

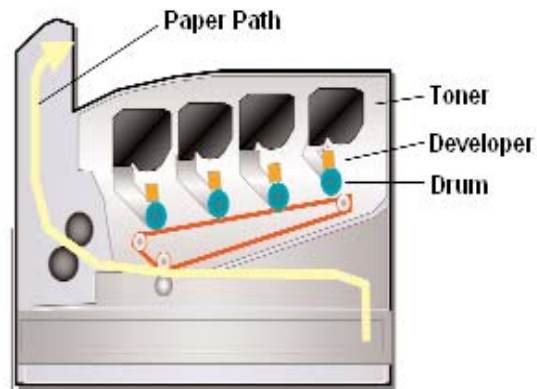

The FS-C5020/30N features 600 x 600 multi-bit dpi image quality with 16 and 24 pages per minute Full-Colour and Monochrome output speeds respectively for each machine. The FS-C5020/30N can be configured with Automatic Duplexing, a choice of Network Interface Cards, additional 500 sheet paper Drawers, an Envelope Feeder, a 20GB Hard Disk Drive, and additional memory to meet the demanding colour imaging requirements of bottom-line conscious corporations.

Consider These Other Outstanding Features:

Small Footprint

Most tandem colour printers are large in size to accommodate four sets of developing units and drums. The FS-C5020N/30N however, was intentionally designed to be compact, lightweight, and about the same size as a standard monochrome laser printer.

Actual comparison



Xerox 6250
Brother 4200CN
K.Minolta 3300

HP CLJ4650

FS-C5020N
FS-C5030N

Plus, since the FS-C5020N

and FS-C5030N only weigh 22 and 23 kg respectively, and they have easy resin grips, these machines doesn't require two people to lift or move the devices.

Fast Printing

The FS-5020/30N possesses high-speed 16 and 24ppm printing with fast processing of complex data so busy office workers don't have to wait for their output. What's more, the FS-C5020N and FS-C5030N maintain most of their full-rated speed when duplexing! Users don't have to compromise speed when reducing paper consumption and document storage space.

FS-C5020N and FS-C5030N Key Features

Printer	Simplex Speed	Duplex Speed
FS-C5020N	16ppm	16ppm
FS-C5030N	24ppm	24ppm
DocuPrint C1618	16ppm	10ppm
Magicolour 5440DL	25ppm	12.8ppm
DocuPrint C2535A	25ppm	14.8ppm
Magicolor 5430DL	20ppm	12.8ppm
OKI 7200/7400	12ppm	10ppm

High-Quality

In addition to Kyocera's original Multi-Bit image processing technology, as an enhancement over the FS-C5016N, Kyocera has developed and incorporated Normal (2 bit) and Fine Colour (4 bit) Technology hardware and Intelligent Colour Technology software in the FS-C5020N and the FS-C5030N to create smoother and consistent high-quality prints.

Standard Connectivity

The FS-C5020/30N supports TCP/IP, IPX/SPX, NetBEUI, and AppleTalk protocols enabling communication to the Printer from network environments such as; Windows, Macintosh, UNIX, NetWare, etc.

When used in conjunction with a customer's eMail system, the FS-C5020/30N's networking supports advanced POP3 functionality allowing users from anywhere in the world to output a document on the Printer by sending the file as an eMail attachment.

Hard Disk Drive Storage

An optional 20GB Hard Disk Drive transforms the FS-C5020/30N from a Page Printer to a Document Printer, and adds the following capabilities:

- Job Storage
- Quick Copy
- Private Print*
- Proof and Hold*
- Virtual Mailbox

** can be used when HDD is not installed by using Printer RAM*

Variable Gloss

Virtually all Colour Copiers, Thermal Wax Transfer, and Colour Laser Printers produce a glossy image. Although this is sometimes appealing when printing photographic images, the majority of business users generate documents containing text and charts. Furthermore, business documents require the ability to make notations or corrections, which is virtually impossible when the output is too glossy.

FS-C5020N and FS-C5030N Key Features

By activating the Glossy Mode setting within the FS-C5020N or FS-C5030N's Operation Panel or the KX Driver, users have the ability to print glossy output for photographs or presentations. When generating business graphics or working documents requiring editing, approval signatures, or comments, users may choose *Low-Gloss Mode* to produce printed pages with less sheen or for different presentation styles.

Note: The Variable Gloss setting can be adjusted to either High or Low. The output speed of the FS-C5020/30N will be reduced when Gloss Mode is used. It is not available for Transparencies.

ECOSYS Concept

The FS-C5020/30N is an ECOSYS Printer, which means it is based on Ecology, Economy, and System. Kyocera is dedicated to the welfare of the environment and developed the FS-C5020/30N within the guidelines of the ECOSYS concept: they are environmentally friendly because they eliminate unnecessary waste and utilise long-life drums to significantly reduce their cost per page.



Although ECOSYS printers also include Monochrome, the concept has even more impact in Colour devices because it provides a significant cost advantage, and helps differentiate the FS-C5020/30N printers from the competition. The ECOSYS concept makes a difference, not in specifications, but in overall concept. ECOSYS printers are the only line of printers on the market developed with customer cost savings in mind from inception to production.

Low CPP

With Kyocera's long-life technology, and the FS-C5020/30N's ECOSYS technology, Full-Colour and Monochrome CPPs are very low.

Total Cost of Ownership (TCO)

With sales of Colour Laser Printers on the rise, savvy organisations view TCO as an important consideration during the acquisition process. However, the majority of prospects only evaluate the initial acquisition price and pay little attention to the consumable and long-term maintenance costs. Successful sales representatives focus on this strategy as opposed to "speeds and feeds" to distinguish themselves from their competitors.

Kyocera realised the significance of TCO and utilises long-life technology and Maintenance Kits to ensure an aggressive TCO.

EcoPrint*

Using the FS-C5020/30N Operation Panel or the KX Driver, users can activate EcoPrint Mode to reduce Monochrome and Full-Colour Toner consumption by as much as 50%. This mode is a perfect way to further reduce TCO and can be used when printing document drafts or any information not requiring high-resolution. (Off, 75%, 50%)

*KPDLL3 Only Function

FS-C5020N and FS-C5030N Key Features

EcoPower (Sleep Mode)

The FS-C5020N and FS-C5030N have a built-in a power-saving feature called EcoPower - the period of time before the FS-C5020/30N enters a power-saving or "Sleep" Mode. Adjustable from the Operation Panel or from the workstation, the FS-C5020/30N is configured with a default factory setting of 15 minutes. In addition to turning this feature "off", users can adjust this setting from a range of 5 minutes to 240 minutes, in 5-minute increments.

Throughput Capabilities

Corporate Colour users are increasingly more demanding of Colour imaging equipment. Features such as multiple paper sources, combined with the ability to print onto a wider range of paper stock, sizes, and weights are becoming key buying criteria with potential buyers.

Multi-Purpose Tray (MPT)

The MPT capacity is approximately 100 sheets. Stocks up to 200gsm ranging in size from 70mm x 148mm to 216mm x 297mm can be fed through this paper source.

MPT First Mode (Automatic Feeding from MPT)

Activation of this feature assigns highest priority to paper fed from this tray. If the MPT contains paper, the first sheet is always selected and fed from this tray, even when a user specifies paper to be fed from another tray. Once the MPT paper supply is depleted, paper is taken from the original drawer selected in the Driver when the job was sent to the Printer. Duplexing from the MultiPurpose Tray is only available in First Mode. The MPT paper size and paper type must be the same as those of the current paper cassette or a paper jam may occur.

Note: First Mode is NOT the Default Factory Setting.

Multiple Interfaces Mean Flexibility

The multiple interfaces available on the FS-C5020/30N makes this printer very useful in corporate workgroups. The FS-C5020/30N has a Hi-Speed USB2.0 Port allowing users to easily connect a laptop PC anytime and print without rebooting. Using the standard networking capability of the FS-C5020/30N, users can print directly from the Internet or print an eMail attachment using POP3 functionality. This means a salesperson traveling overseas can print to either the FS-C5020N or the FS-C5030N in their office through the internet using the device's IP Address. In addition to these standard interfaces, the optional IC159-WLAN Wireless Networking Board allows Printing without troublesome cabling. This all adds up to a flexible, full-colour corporate resource that no business should be without.

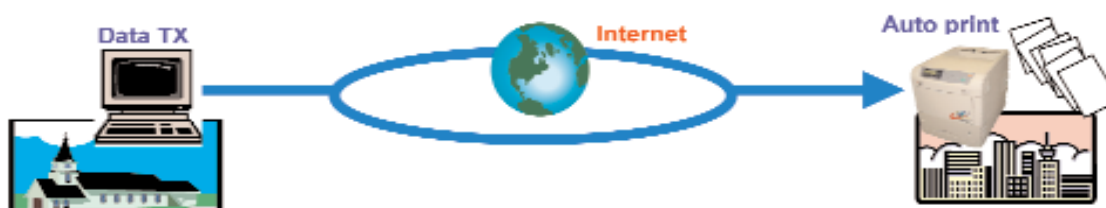

FS-C5020N and FS-C5030N Key Features

Photoconductive Drum Composition

All FS-C5020N and FS-C5030N Printers utilise extremely efficient (OPC) Organic Photo Conductor Drums (four separate imaging units) requiring replacement after 200,000 images. This compares to competitive solutions typically needing replacement between 7,000 and 40,000 images for full-colour, and 3,000 and 13,000 images for monochrome

Consumable Characteristics

Kyocera has applied a high quality resin coating to the FS-C5020N and FS-C5030N's Carrier, which helps to maintain electrification characteristics and minimises premature deterioration that can occur when toner particles adhere to the Carrier. The addition of the resin coating provides a 200,000 high quality image yield for the FS-C5020N and FS-C5030N carrier versus competitive Colour devices requiring a carrier/developer change every 40,000 images.

Enhancements to the FS-C5020N and FS-C5030N from the FS-C5016N

Along with any product update, the FS-C5020N and the FS-C5030N have several enhancements incorporated into them to continue the success of these products. These enhancements improve upon two major categories in which customers consider when purchasing a colour printer: Productivity, and Quality.

To increase productivity Kyocera first decreased the time it takes for these machines to calibrate to about 29 seconds. Users don't have to wait as long for their machines to calibrate. In addition, rather than have the calibration be timed to perform every 80 pages and force the possibility of a calibration in the middle of a job, the FS-C5020N and FS-C5030N now perform their calibrations at the end of their jobs anywhere in between 70 and 80 pages. The machine will wait until that job is complete before it performs it's calibration. (In between 70 and 80 pages)

In addition, Kyocera has focused on several quality enhancements. These enhancements ensure that the FS-C5020N and FS-C5030N have the highest quality prints and reliability throughout their lives.

Another great enhancement, and new feature on the FS-C5020N and the FS-C5030N includes the ability to view the CMYK colour coverage breakdown of the last printed page. Now you can calculate and show exactly how much demo originals will cost your prospect. Simply print a status page from the "Others" menu. The coverage information is located at the bottom. See page 27 for more information on how to print a status page with either your FS-C5020N or FS-C5030N



This page intentionally blank

FS-C5020N and FS-C5030N Technology

The FS-C5020N and FS-C5030N achieve excellent image quality for users in today's demanding office Colour environments. Kyocera utilises a combination of technological enhancements to achieve consistent image quality regardless of the print volume generated. These enhancements include:

Multi-Bit Technology

This dithering technique enables the FS-C5020/30N to achieve high-quality output when printing a variety of images, especially continuous-tone photographs. Additional benefits of this technology include:

- Sharper Text
- Virtual Elimination of Banding
- Smoother Gradations

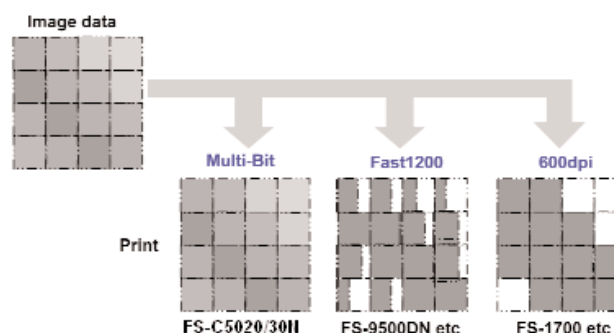

Kyocera Fine Colour Technology (FCT)

FCT consists of the following innovative Kyocera Mita developed processes: Advanced Beam Array, Touch Down Development, and Belt Transfer.

Advanced Beam Array

This advanced method, which is superior to LED printing, contributes to the FS-C5020N and FS-C5030N's small sizes. ABA can maintain consistent crisp, sharp images because the Kyocera Advanced Beam Array has controls to make uniform dots of light.

Touch Down Development

This unique system is based on the combined advantages of mono (high-quality) and dual (long-life) component development. The FS-C5020/30N's Developing Roller allows the toner to jump onto the Drum, which increases drum life and maintains high-quality imaging.

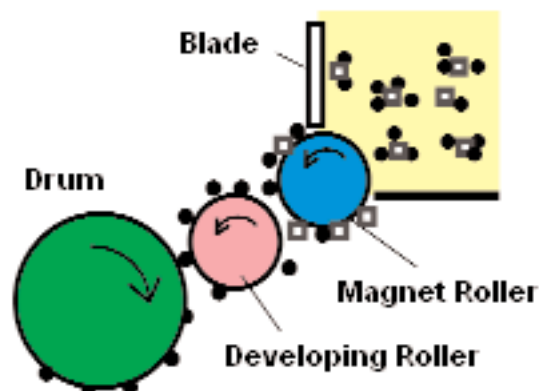

Belt Transfer

This Kyocera developed process significantly contributes to low TCO. Since the paper never touches the Drum, wear and tear is reduced and paper dust is eliminated, thus increasing the Drum life. In addition, overlapping colours are consistently aligned since the four colour toners are transferred to the paper at the same time. Plus, the Transfer Belt has a tri-layer coating, which increases durability and smoother paper feeding.

FS-C5020N and FS-C5030N Technology

Kyocera Intelligent Colour Technology (ICT)

ICT has three components: High-Speed Data Processing, High Speed Image Processing, and High-Image Quality.

High-Speed Data Processing

DDR SDRAM technology is the newly adopted memory method. Its data transfer speed is twice as fast as existing SDRAM technology, which contributes to the improvement of total print performance.

High Speed Image Processing

Improved RGB to CMYK colour conversion and image generation speed allows faster processing of files containing colour images.

High-Image Quality

Documents containing a mixture of text, graphics, charts, graphs, and photos are printed clearly and precisely because each unique page element is processed independently to provide the highest image quality possible.

Environment Adoption Stabilisation System (EASS)

Maintaining consistent image quality when utilising Advanced Beam Array technology is effortless with EASS. Fluctuations in environmental conditions such as temperature and humidity can cause image quality to “drift” resulting in the same image appearing differently when printed on two separate days. Kyocera includes sensors and developed unique technology to adjust toner concentration levels within the FS-C5020/30N, virtually guaranteeing consistent image quality regardless of environmental conditions.

Oil-Less Fusing

Newly developed polymerised toner eliminates the need for an Oil Roller, which reduces cost per print and service calls.

Colour Matching

With the FS-C5020N and FS-C5030N you can satisfy Colour matching requirements by using the Colour Tab in the KX Driver. (covered later in this guide) This function offers the ability to output a variety of ink and monitor simulations.

Colour Control

For those who want to make more refinements to image quality, users have the ability to make setting adjustments to Hue, Lightness, and Saturation within the KX Driver. In addition, Colour Reproduction Modes such as Picture Image, Text, Chart/Graphic, and four automatic modes can be specified within the Driver.

Automatic Colour Calibration

Another tool ensuring optimum image quality is Automatic Colour Calibration. Calibration takes place when the FS-C5020/30N is powered on, when the engine has been inactive, and during long print runs to maintain colour quality and consistency. It can also be user requested at any time from the Control Panel. When the FS-C5020/30N is calibrating, a Control Panel message states: “Please Wait (Calibrating)”. The process is very brief, and is done to ensure that the quality of Page 1 is as good as Page 3,001.

FS-C5020N and FS-C5030N Productivity

Speed

In addition to creating a solution with output speeds of 16 and 2 pages per minute respectively in Full-Colour and Monochrome, Kyocera has incorporated the following components to enhance overall user productivity and efficiency.

Electronic Sort*

Electronic Sort provides Send Once - Print Many technology producing multiple sets from one print job. This means a multi-page report is sent once - Send, RIP, Print, Print, Print, etc., saving time and eliminating network traffic. Without Electronic Sort, data is sent to the Printer for each set required - Send, RIP, Print, Send, RIP, Print, etc.

e-MPS

e-MPS is an abbreviation for “enhanced-Multiple Printing System” and requires the installation of the optional 20GB HDD. e-MPS provides added convenience and performance when using the Printer’s Control Panel to reprint and/or access documents stored on the Hard Disk Drive. In addition to reducing network traffic, e-MPS provides faster printing with less PC spooling time.

e-MPS capabilities include:

1. **Quick Copy** - Activation of this feature enables users to print additional sets of documents directly from the Printer without having to return to their workstation and re-send the file to the Printer. The default number of print jobs able to be stored is 32. This can be increased to 50 from the e-MPS Configuration Menu. When the maximum number of jobs has been reached, the oldest job will be overwritten. Users can choose application defined or assign a custom name within the Print Driver. Jobs are stored after printing, but deleted when the Printer is powered off.
2. **Proof and Hold*** - When this feature is activated, only the first set of a multiple set document is printed, enabling users to proof the document before outputting the remaining sets. After proofing, users have the ability to cancel or print the remaining job from the Operation Panel. The default number of print jobs able to be held is 32. This can be increased to 50 from the e-MPS Configuration Menu. Jobs are stored after printing, but deleted when the Printer is powered off.
3. **Private Print*** - When printing confidential documents, users can input a four digit PIN from the KX Print Driver before sending their job to the Printer. The Printer will hold the job(s) until the user enters the same four digit PIN into the Operation Panel to release the job for printing. The number of jobs able to be stored using Private Print depends on the free space remaining on the HDD. The jobs are automatically deleted after the PIN is entered or when the Printer is powered off.
4. **Job Storage** - This timesaving feature enables users to store and recall frequently printed documents; such as fax covers, directions, checklists, and order forms on the Hard Disk Drive, and recall them using the Operation Panel. The number of jobs able to be stored using this feature depends on the free space remaining on the HDD. Jobs are stored after printing, and are not deleted when the Printer is powered off.
5. **Virtual Mailbox** - Part of Job Storage, Virtual Mailbox stores jobs on the Hard Disk without printing. It enables users to retrieve jobs from the Operator Panel, or the KM-NET Printer Disk Manager Utility (on the KM Driver Library CD). Up to 255 Virtual Mailboxes can be created. Each Mailbox may be used by an individual who wants to share the Printer in this mode. By default, each Mailbox is numbered from ‘Tray 001,’ ‘Tray 002,’ . . . etc. To ‘post’ a job in a Mailbox, users assign a numbered or named mailbox within the Print Driver when printing. Virtual Mailbox can be used in PCL 6 emulation only.

* can be used when HDD is not installed by using Printer RAM

FS-C5020N and FS-C5030N Productivity

	Quick Copy	Proof and Hold	Private Print	Job Storage
Primary Function	Prints additional copies from Printer instead of computer	Proofs first copy before printing multiple copies.	Holds document at printer to prevent unauthorized access	Electronically stores documents such as fax cover pages
Retrieved By	Operator Panel	Operator Panel	Operator Panel	Operator Panel
Default # of Copies Printed When Retrieved	Same as Stored; Can be Changed	One Less; Can be Changed	Same as Stored; Can be Changed	One; Can be Changed
Max # of Stored Jobs	32, expandable to 50	32, expandable to 50	Depends on HDD Capacity; Private jobs are deleted automatically after retrieval.	Depends on HDD Capacity
PIN Security	No	No	Yes	Yes (if necessary)
Data After Printing	Stored	Stored	Deleted	Stored
Data at Power Off	Deleted	Deleted	Deleted	Stored
Requires HDD	Yes	No	No	Yes

Total Counts System Solution

Using KM-NET Account Manager, accurate print counts are collected electronically saving time, improving efficiency, and increasing productivity. In addition, the total count is listed on the Status Page and is accessible from the Control Panel.

Remote Maintenance System Solution

Using KM-NET@Service, customer meter readings are automatically collected and sent via eMail to the designated dealer, improving customer relations by offering prompt service activities.

Standard PDF Direct Printing

PDF, created by Adobe, is an acronym for Portable Document Format. It uses the PostScript printer description language and is highly portable across computer platforms. Since PDF files contain layout formatting, fonts, and graphics from the original document, it is the ideal language for printers. PDF has been widely accepted as the industry standard for document exchange and publishing. They are created with Adobe Acrobat and can be viewed with Adobe Acrobat Reader or other PDF reader programs. The FS-C5020N and the FS-C5030N supports direct printing of PDF files, which means users can print a PDF file without opening the application.

Optional Accessories

Configurations

The FS-C5020N and FS-C5030 are available with a variety of options. All versions offer 600 x 600 dpi Multi-Bit Technology to ensure optimum imaging quality.

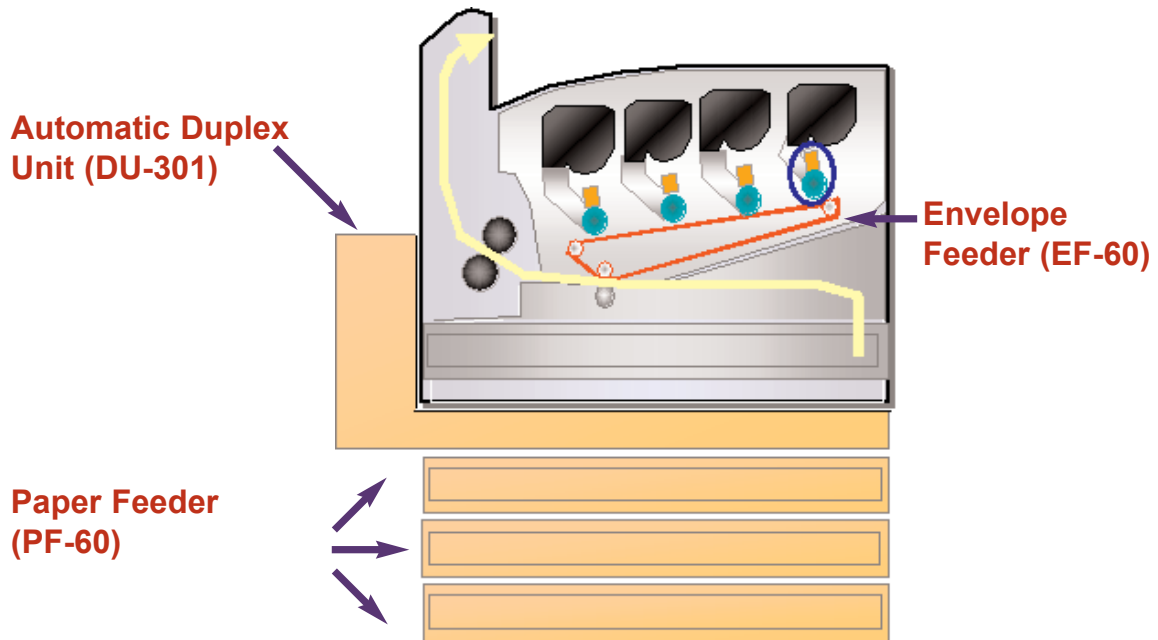

Automatic Duplex Unit (DU-301)

The FS-C5020/30N offer optional Automatic Duplexing for papers ranging from A4 to B5. See page 9 for more information on the rates and speeds of duplex printing.

Paper Drawers (PF-60)

The FS-C5020/30N can be configured with up to three additional 500 Sheet paper drawers for a total capacity of five online paper sources totaling 2,100 sheets.

Envelope Feeder (EF-60)

Now customers can print custom envelopes for Direct Mail campaigns, for billing purposes, or for general marketing mailings. This optional accessory prints envelopes fed lengthwise - with the side to be printed facing-up. Up to 40mm or 1.5" height capacity.

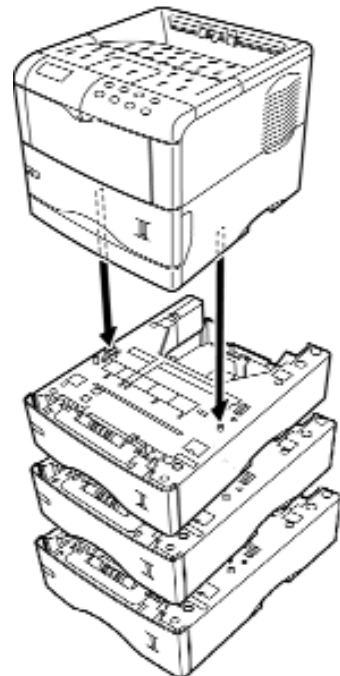

Optional Accessories

The EF-60 supports the following envelope sizes:

Monarch	3 7/8" x 7 1/2"	98 mm x 190 mm
Business Com10	4.1/8" x 9.1/2"	104 mm x 241 mm
International DL	-	110 mm x 220 mm
International C5	-	162 mm x 229 mm
Commercial 9	3 7/8" x 8 7/8"	98 mm x 225 mm
Commercial 6 3/4	3 5/8" x 6 1/2"	92 mm x 165 mm

Expansion Memory

Each Printer is shipped with 128MB of memory (DDR SDRAM). To expand the memory for more complex print jobs and faster processing (RIP) speeds, optional DIMMs (Dual Inline Memory Modules) may be installed in the two memory slots provided on the Printer's main board. Additional memory in 64, 128, 256, or 512MB modules can be installed by a technician.

Compact Flash Memory Slot

The FS-C5020N and FS-C5030N Printers are equipped with one Compact Flash Card slot. Users requiring access to additional fonts not installed within the Printer, can use an optional Font Card to add fonts to the device. The Font Card is read, via commands found on the Control Panel, automatically when "powering on," or when resetting the Printer. Specific fonts to be placed into the FS-C5020/30N Printer memory can be selected from the Operation Panel. In addition, a Compact Flash Card can be used to store graphics such as logos and letterhead information at the Printer, without requiring that data to be sent over the network every time a document is printed. (Supports cards up to 256MBs.)

Hard Disk Drive (HD-ME4)

The optional 20GB Hard Disk Drive installed in the KUIO slot can be used to store print jobs, fonts, macros, reduce the frequency of data sent from the workstation to the Printer, and enable e-MPS (enhanced Multiple Printing System) capabilities, and allow Electronic Sort.

Adding the Hard Disk Drive converts the FS-C5020/30N from a Page Printer to a Document Printer. Since the print job is sent only once for multiple sets, network traffic and computer spooling time are dramatically reduced.

Network Interface Cards

IB-11

The IB-11 supports the connection of RS-232C Serial devices.

IC159-WLAN

The IC159-WLAN is the IEEE 802.11b Wireless interface card that allows users of laptops or mobile devices to print to the FS-C5020N or FS-C5030N without physically connecting to the network.



Optional Accessories

	IB-11	IB-21e	IC159-WLAN
KUIO Interface	KUIO/LV 5.0 Volts	KUIO/LV 3.3 Volts	KUIO/LV 3.3 Volts
Network Interface	Serial	10BaseT 100BaseTX	Wireless IEEE 802.11b
Flash ROM	-	1MB	1MB
RAM	-	4MB	2MB
Data Transfer	115200 bps max	DMA	DMA



This page intentionally blank

FS-C5020N and FS-C5030N Controller

The FS-C5020N and FS-C5030N are equipped with a PowerPC 750Cxe 400 MHz and PowerPC750FX 600 MHz Controller respectively, 128MB of DDR RAM, and 8MB of System ROM to efficiently process complex files. In contrast, CPUs found on some competitive models utilise a slower processor and only SDRAM to process files. Finally, the FS-C5020/30N Controller can be configured with additional memory with the two additional memory slots for a total of 1024MB of increased processing memory.

The FS-C5020/30N features four Page Description Language emulations: KPDL3, PCL 6 (PCL 5C/PCL XL), PRESCRIBE, and PDF Direct Print satisfying virtually all PDL requirements in today's corporate environments.



Standard Interfaces

The FS-C5020N and FS-C5030N both have a Parallel, Hi-Speed USB 2.0, and a 10/100BaseTX network card. In addition, There is one KUIO-LV at the rear of the printer for the optional interface boards: IC159-WLAN (wireless), and IB-11 (serial interface).

Printing a Status Page

Unlike a Copier, what's installed within a Printer, such as additional RAM or a Hard Disk Drive, cannot be determined by merely looking at the device. Therefore, Printing a Status Page provides the user a variety of important information about the that device. The status page also shows the user what the CMYK colour coverage breakdown.

To print out a Status Page, follow these simple steps:

1. Press "Menu Key" on the FS-C5020N of FS-C5030N Operation Panel.
2. Press the right arrow until "Print Status Page" appears.
3. Press the "Enter" Key two times.
4. The message "Processing" followed by "Ready" will appear on the panel as the Status Page is generated.

To view the CMYK Colour Coverage breakdown, Under "Services", advance to "Others", then right to "Print Status Page". Press "Enter" twice.



FS-C5020N and FS-C5030N Controller

Following is a brief overview of each area. For additional details please review the FS-C5020N or FS-5030N User Manuals.

Firmware Version and Release Date

This area shows the version and release date of the Printer firmware.

Hardware Information

Here you will find information for the Paper Drawers and MPT such as: the number of drawers, and the size and type of the paper installed. This area will also list Printer settings, such as Buzzer OFF/On, the Host Buffer Size, the Sleep Timer, and FormFeed Time Out Settings.

Page Information

This area displays the Number of Copies and Total Page Count and whether Tone Mode is Normal or Fine.

Network Status

This area lists the IP Address, Subnet Mask, and default Gateway, information for the installed Network Interface Card.

Memory

This area states the total memory installed, available memory space, and the current status of the RAM Disk.

Installed Options

This area lists whether the HDD, Option ROM, and Memory Card are installed.

Emulation

This area shows available emulations for the FS-C5020N or the FS-C5030N (PCL 6 is the factory default). The emulations are: PCL 6, KPDL3, KC-GL.

Error Log

The last three errors, listed in order of occurrence, will be displayed here. The most recent error will appear on the topmost line of the Log. Error information is cleared when the printer is powered off.

Consumable Status

This area displays the approximate level of remaining toner. When the Toner Counter states 100, the container is full. The closer the level gets to zero, the emptier the toner cartridge becomes.

Interfaces

This area displays the standard and optional installed interfaces: Parallel, Network, USB and Option.

KX Driver

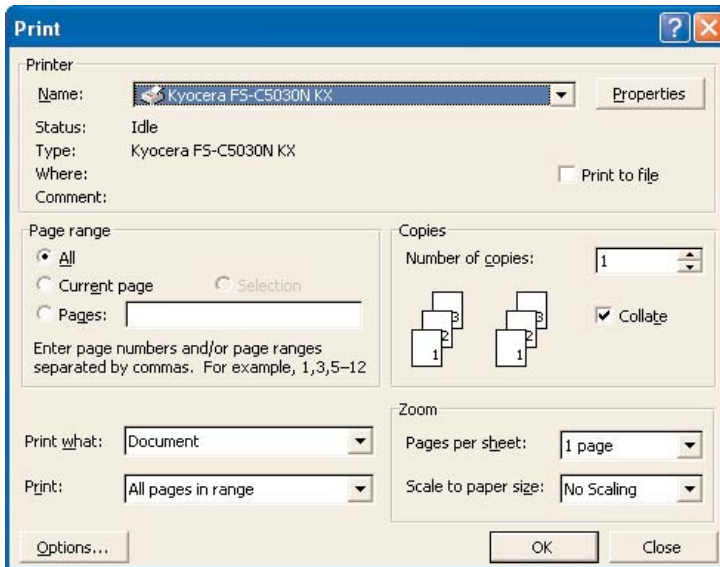

The screen pictured here appear when [Print] is selected from a software application, (in this case MS Word). By selecting [Properties] found in the upper right corner, users can modify selections on the KX Driver's nine tabs: Media, Layout, Imaging, Colour, Output, Prologue/ Epilogue, *Watermark*, *Profile*, and About.

The following section provides an overview of the features activated under these tabs.

For additional information, please review the FS-C5020N or FS-C5030N Printer Operation Guides.

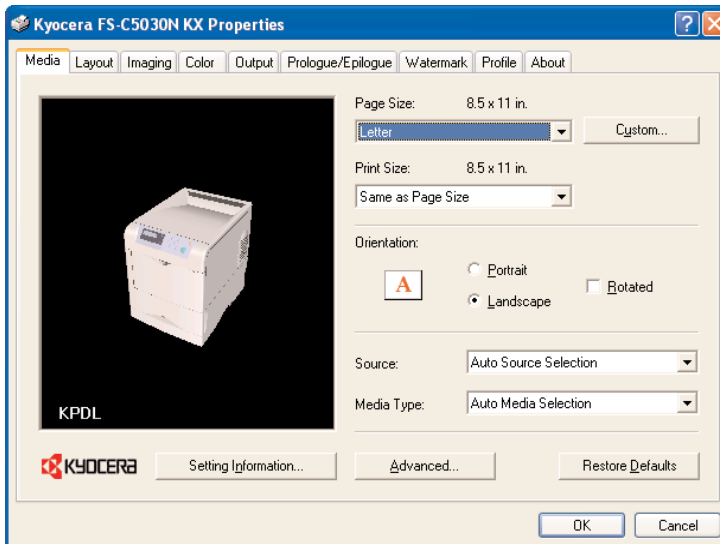

Media Tab

This tab enables users to access the following features:

Page Size - The size of the document created in the application.

Print Size - The size of the document being printed on the FS-C5020/30N. Typically, the Page Size and Print Size should match.

However, if a user creates an 279mm x 429mm document in a software application and wants to print using A4 size paper, the FS-C5020/30N will automatically reduce the document by 64% to fit onto the Letter size paper.

Orientation - As with any Printer, users can select Landscape or Portrait and have the ability to Rotate the image. Based on the orientation of the paper in the drawer, users can activate Rotate to ensure the proper positioning of the image on the page.

Source - Activation of this pull down menu enables users to select the Paper Drawer - based on the size of the output paper desired for each job.

Media Type - Users can select from fifteen different types of paper stocks including Plain Paper, Transparency, Envelopes, Preprinted, Labels, Heavy Stocks, plus eight Custom Stocks.

KX Driver

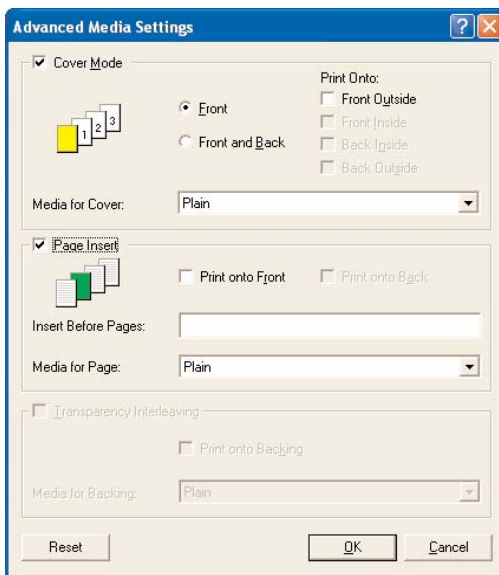

Advanced Media Settings

When **Advanced** is selected from the Media Tab, users can choose Front Only or Front and Back Covers, and whether they should be printed or blank. Users can also specify the Cover paper type or the paper source. Additional features available include, Page Inserts and Transparency Interleaving.

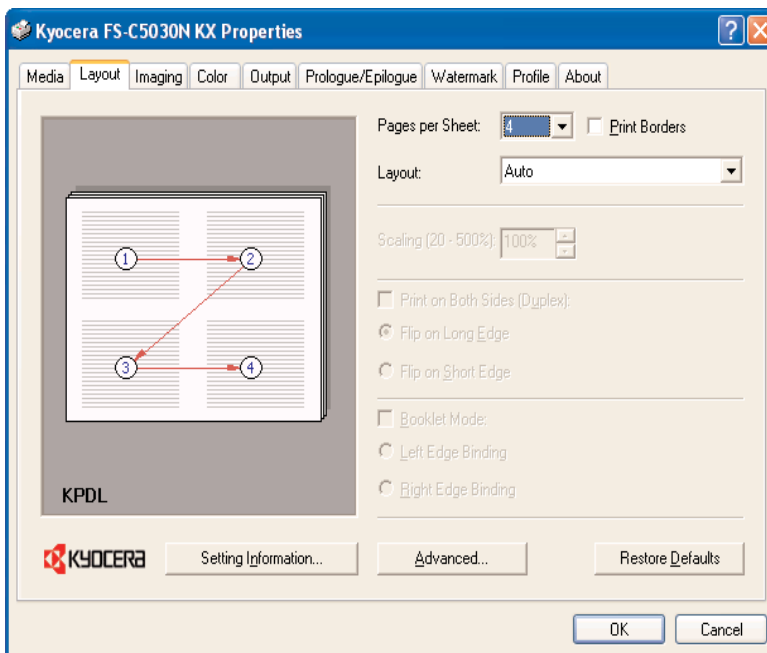

Layout Tab

Pages Per Sheet - This feature, used to reduce paper consumption, can be used when printing drafts of a presentation or when archiving large documents. It enables users to place up to 25 pages onto a single sheet of paper.

Print Borders - When printing multiple pages on a sheet, activation of this feature places a border or frame around each document.

Layout - Activation of this feature allows users to select from nine different orientations when placing multiple pages on a single sheet. Users can choose from *Auto*, *Bottom to Top*, *Top to Bottom*, *Right to Left*, and *Left to Right*. To assist with visualization, each selection is illustrated on the page layout screen beside the selection.

Scaling - Users have the ability to reduce or enlarge the printed data in one percent increments from 20% to 500%.

Print Both Sides - When Duplexing, users can choose between *Flip on Long Edge* or *Flip on Short Edge* based on how their documents will be Bound or Stapled.

Booklet Mode - Also known as Signature Imposition, activation of this feature takes a multi-page document from any application, and creates double-sided pages that create a booklet when folded in half.

KX Driver

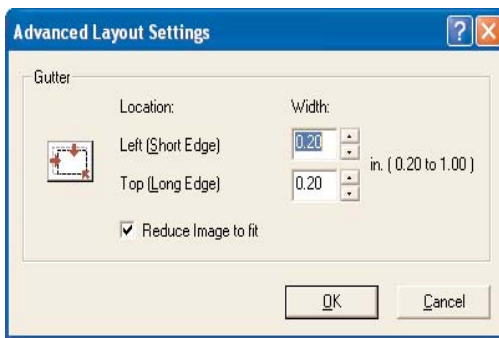

Advanced Layout Settings

When **Advanced** is selected, from the Layout Tab, users can choose a Gutter Width from .2 to 1.0, and specify whether the gutter should be on the left or top of the page. In addition, users can choose to print the entire page by selecting *Reduce Image to Fit* (default), on pages where text or an image extends into the gutter.

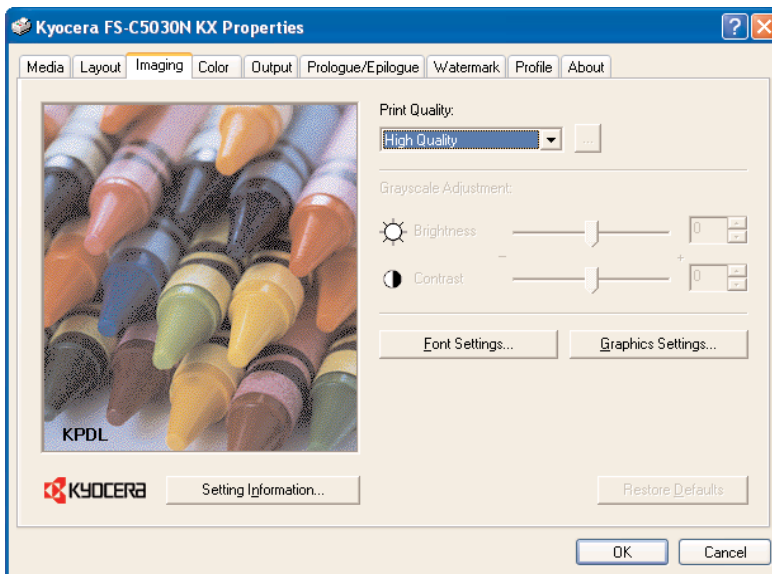

Imaging Tab

This tab enables users to access the following features:

Print Quality - The default setting for this feature is High Quality. By selecting Custom, users can enable EcoPrint - a toner saving feature. (also available at Control Panel.)

Font Settings - This area provides alternative methods for sending TrueType fonts to the FS-C5016N. Users can choose from three methods:

Download TrueType Fonts as Outline - Sends TrueType Font Outlines to the FS-C5020/30N and is the default setting. In rare situations when issues are encountered printing these fonts, users can choose from Download TrueType Fonts as Bitmap or Substitute with Device Fonts.

Download TrueType Fonts as Bitmap - Activation of this feature causes TrueType fonts to be sent as bitmap fonts.

Substitute with Device Fonts - Since activation of this feature uses built-in Printer fonts instead of downloading TrueType Fonts, documents are typically printed faster. Users may find the same document appears different when printed on another printer because the same font may not be available.

Disable Device Fonts - Users select this when all fonts are to be downloaded, thus ensuring accurate output.

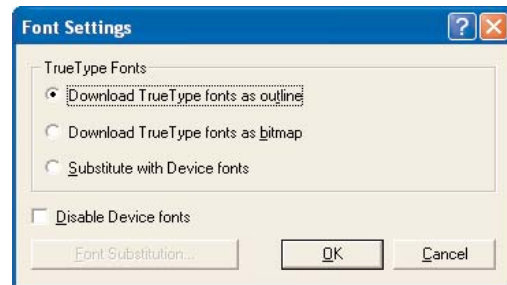

KX Driver

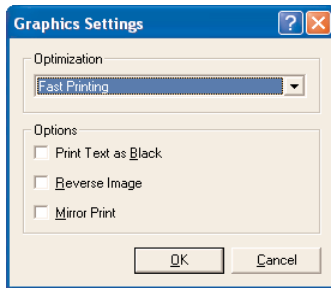

Graphic Settings - This area provides additional options such as: *Print Text as Black*, *Reverse Image*, and *Mirror Print*. Users can also select two options for Optimization: *Fast Printing* or *Document Portability*.

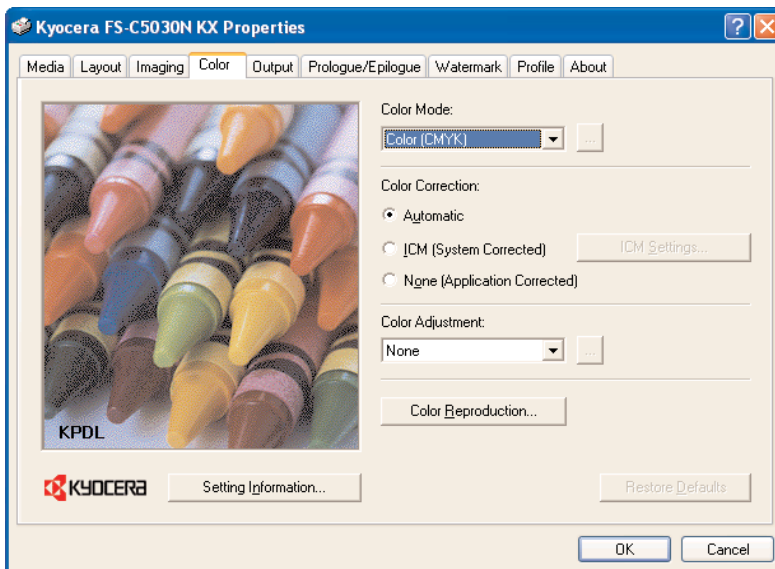

colour Tab

This tab enables users to select the Colour Mode, Colour Correction, Colour Adjustment, and Colour Reproduction.

Colour Mode - Users can select from Colour (CMYK), Monochrome, or Custom.

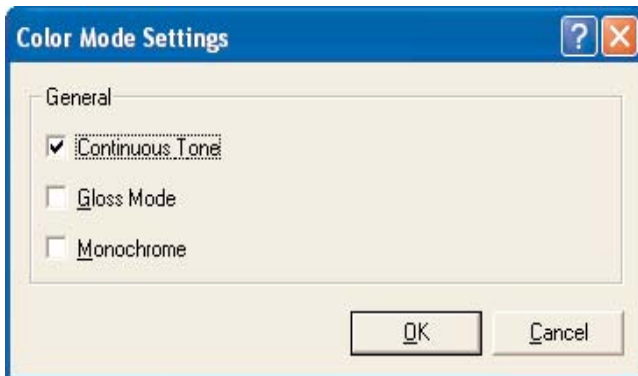

Selecting **Custom** enables users to further enhance image quality with Continuous Tone, Gloss Mode, or Monochrome.

Continuous Tone - Used when printing photographs, this feature, also known as Contone, can be combined with Gloss Mode to provide a shinier appearance for photographic images.

Gloss Mode - Activation of this feature provides a glossy finish to documents, typically desired when printing photographic images. The default setting for this printer is low gloss. Users may change this to high gloss in the KX Driver or through the FS-C5020N or FS-C5030N Operation Panel.

Monochrome - Printing in this mode translates colour into 256 shades of gray using black toner. Users can choose Monochrome printing for faster printing, easier faxing, or document archival. It can be combined with Gloss Mode, but not Continuous Tone.

KX Driver

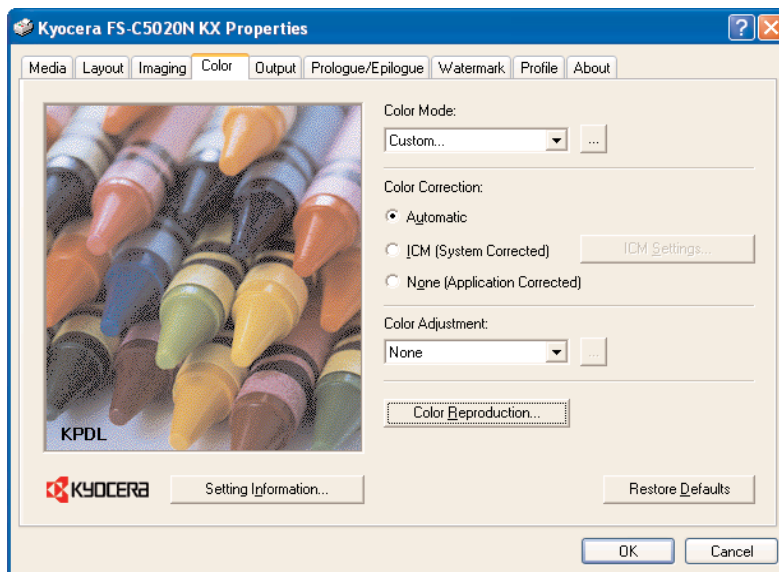

Colour Correction -

Allows users to specify how the FS-C5020/30N processes the conversion from RGB (Monitor Colours) to CMYK (Printer Colours). Users can select from the following Colour treatments: Automatic, ICM (System Corrected), or None (Application Corrected).

Automatic - This is the standard setting and performs Colour matching in accordance with the driver's default Colour profile.

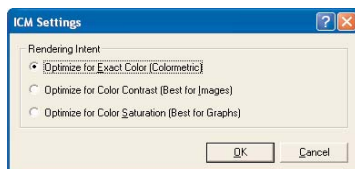

ICM (System Corrected) -

Image Colour Matching, or ICM profiles are used between display and print application software to successfully trade colour information back and forth.

The International Colour Consortium (ICC) developed a standard device profile that contains information about how various devices render colour. There are two parts to the ICC profile. The first part contains information about the profile itself, such as what device created the profile and when. The second part is colourmetric device characterisation, which explains how the device renders colour.

The FS-C5020/30N lets you choose from the following: Optimize for Exact Colour (Colourmetric), Optimize for Colour Contrast, and Optimize for Colour Saturation.

None (Application Corrected) - Activation of this feature utilises the Colour Management controls within the original software application (such as QuarkXPress) to process and print the document.

KX Driver

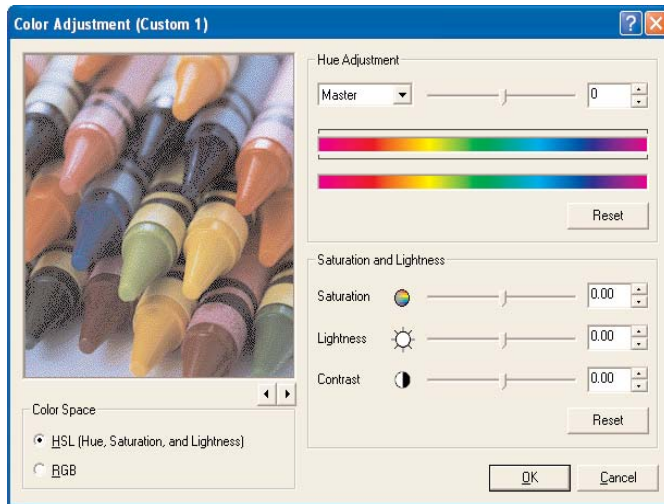

Colour Adjustment - Users can select from None or one of three Custom Settings. When a Custom Setting is selected, this screen appears. Here, users can adjust colour in either of two colour spaces: HSL (Hue, Saturation, and Lightness) or RGB (Red, Green, and Blue.)

To adjust Hue, the Master slider is dragged right or left and modifies the entire image from one Hue to another.

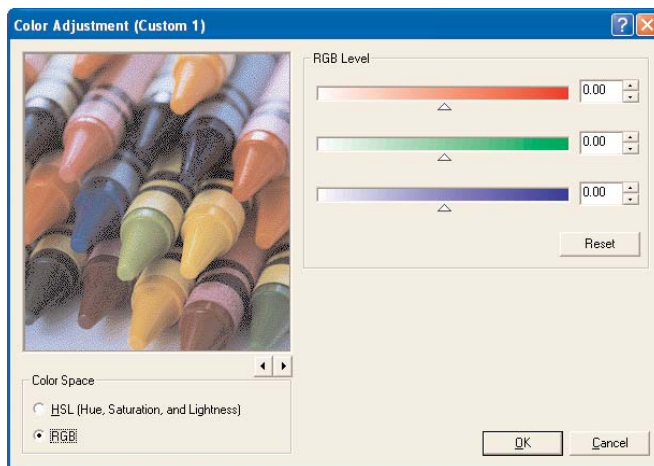

By selecting the RGB colour space, users can adjust the images within their document in terms of Red, Green, and Blue from -10 to +10.

Saturation and Lightness are adjusted in a similar fashion, and users have the ability to return all settings to the default by clicking the Reset key. The Right/Left arrows under the picture, toggles between the crayons, fruit, or a

child's face, allowing users to choose an image that better represents the image within their own document.

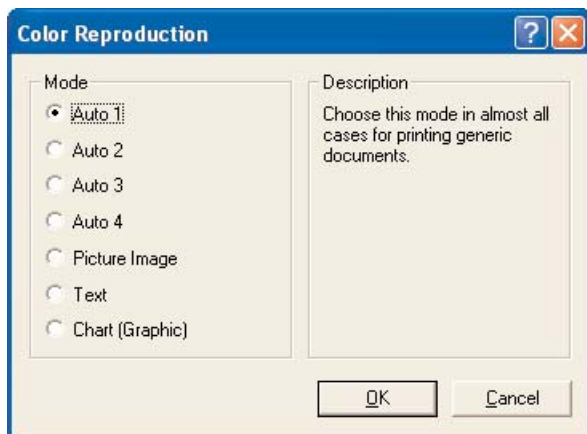

Colour Reproduction - Users can choose from seven choices - with document type recommendations for each:

- Auto 1** Generic Documents
- Auto 2** Black Text & Graphs printed in Black Toner only
- Auto 3** Black Text & Graphs printed in Four Colour (process Black)
- Auto 4** Images and Graphs Similar to Monitor

Picture Image Text

Images, Text, & Graphs similar to Monitor
Images, Text, & Graphs in Vivid Colour - Blacks print in Black Toner only

Chart (Graphic)

Prints Images, Text, & Graphs, printed in Vivid Colour - Blacks printed in Process Black.

KX Driver

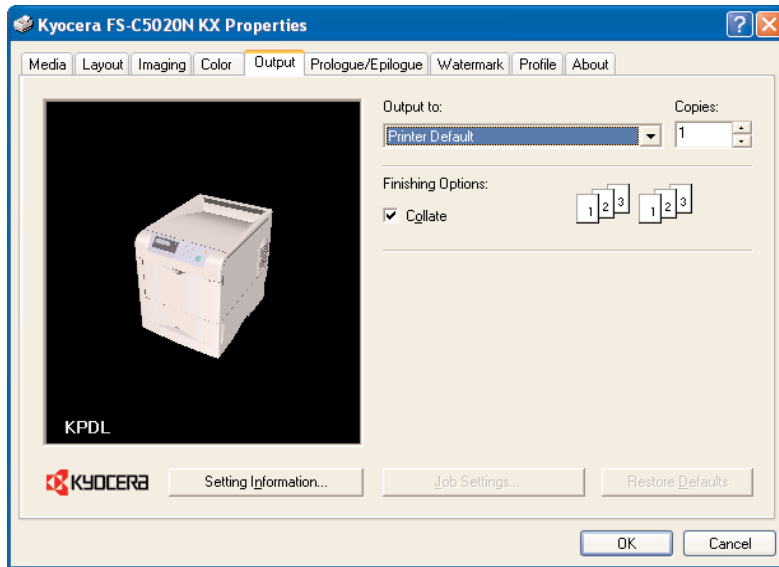

Output Tab

This area allows users to choose where the printed documents will exit the FS-C5020/30N. Users can also choose their method of Collation, and Reverse Page Order. The thumbnails on the right change depending on user's choice to help with clarification and understanding.

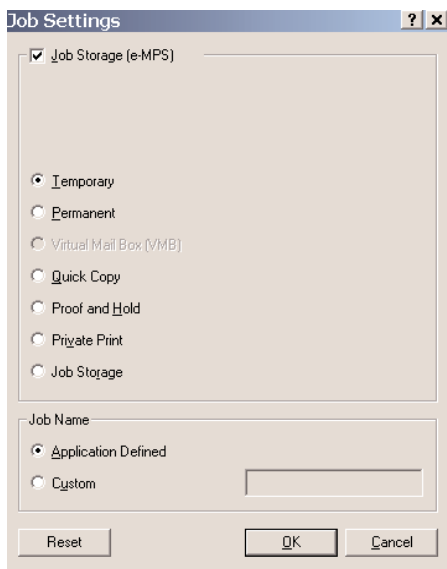

Job Settings - Clicking Job Settings provides access to e-MPS functions, an abbreviation for enhanced Multiple Printing System. When an FS-C5020/30N Hard Disk Drive is installed, e-MPS allows a variety of Job Retention and Job Storage features such as: Temporary or Permanent Storage, Virtual Mailboxes, Quick Copy, Proof and Hold, Private Print, Job Storage, and Job Name, either Application Defined or Custom. See *e-MPS section under Productivity*.

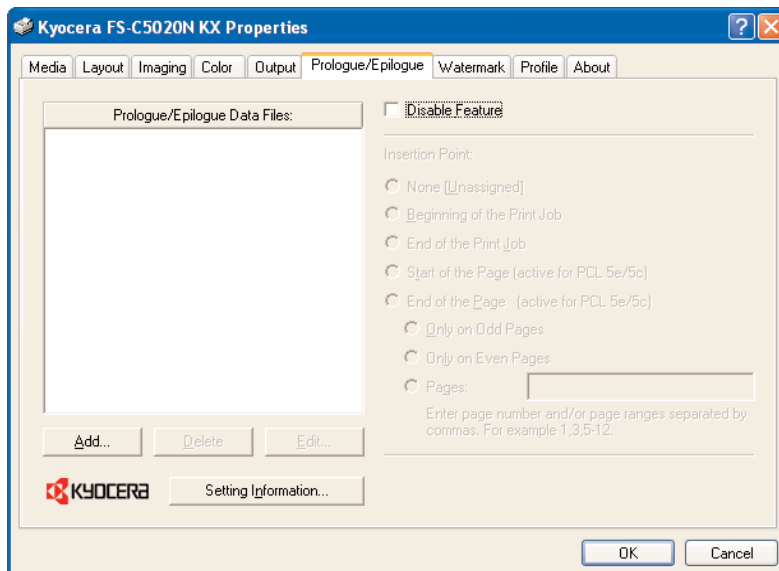

Prologue/Epilogue Tab

The default setting for this tab is Disable Feature. Once this setting is unchecked, users can add electronic versions of pre-printed forms such as invoices, or letterhead to be merged with data sent from a workstation.

KX Driver

To assist in understanding the capabilities of this feature, consider how a document is printed on a company letterhead on a common Page Printer. The user is required to walk to the Printer, load pre-printed letterhead stock, return to their workstation, print the document, walk to the Printer, and finally return to their desk.



Activation of Prologue/Epilogue Feature enables users to call for the electronic version of an invoice or letterhead, previously stored on a Compact Flash Card inserted into the FS-C5020/30N.

By using Prologue/Epilogue Mode, users can write simple PRESCRIBE command files to call out various forms. System Administrators can then use these files to create Printer Icons (company-wide) with the PRESCRIBE file embedded within the Prologue/Epilogue Tab. For example: When users print to the Invoice Printer, their document would print on the Invoice Form stored on the Compact

Flash Card without having to load pre-printed stationary into the Printer.

Advantages of PRESCRIBE include:

- Elimination of printing and storing stationary
- Ability to update stationary electronically
- Reduction of data sent over the network (forms reside on Compact Flash Cards)
- Elimination of loading pre-printed stationary into the printer before each print job

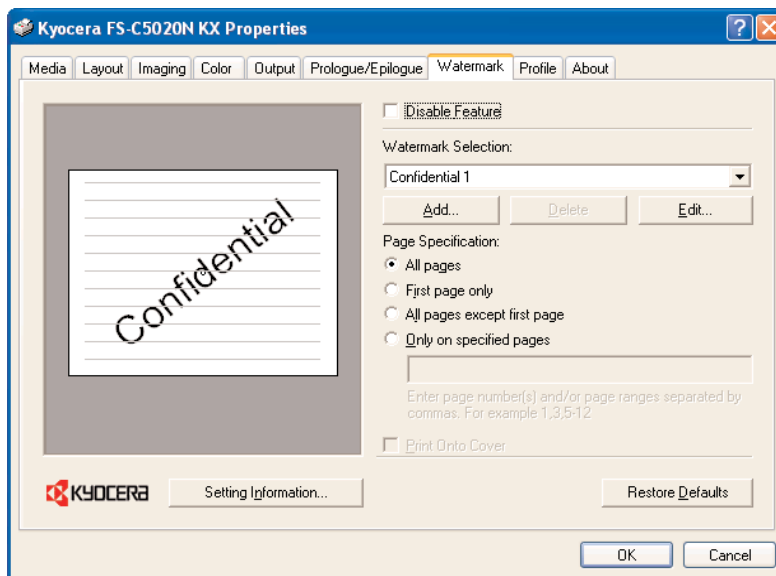

Watermark Tab

Users can choose to apply watermarks to documents either on All Pages, First Page Only, on All Pages Except First Page, or Only on Specified Pages. Under Watermark Selection, users can choose preset selections such as: *Confidential 1 or 2, Copy, Sample*, or click **Add** to type in a custom Watermark. Users can

name the Watermark, and choose the Font, Colour, Point Size, and Style of the Watermark. In addition, the page position and angle can also be specified.

KX Driver

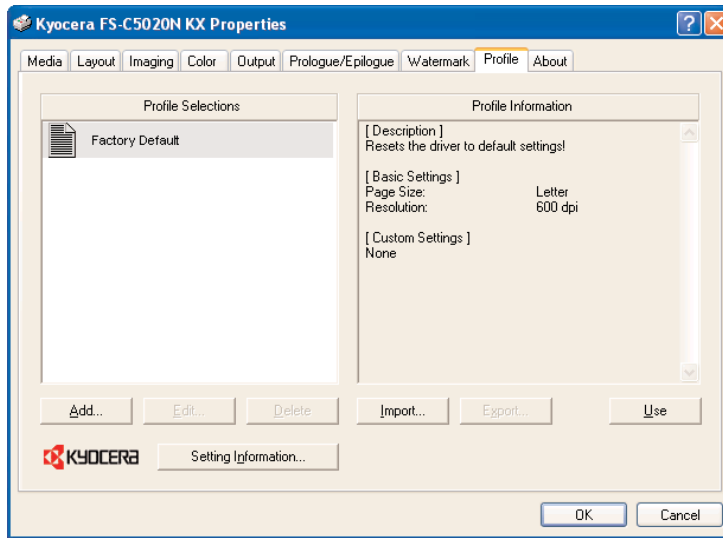

Profile Tab

Users can change settings on the Printer and save them by clicking **ADD**. Here users *Name the Profile*, choose an *Icon Style* for easier identification, and type a *Brief Description* of the profile. When selected, the Information area changes to reflect the chosen settings.

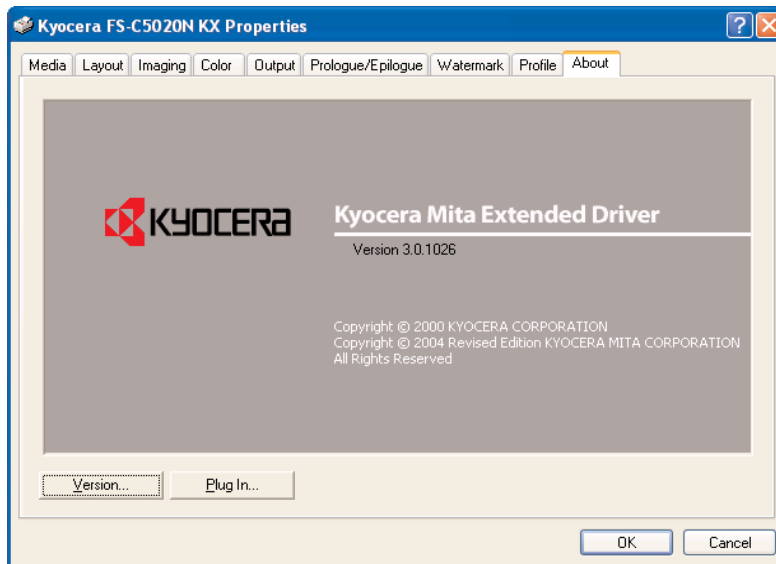

About Tab

This tab enables users to verify the software version of the Print Driver and any installed Plug-ins. A Plug-in is a small software program loaded into memory with the KX Driver to add additional capabilities to the FS-C5020/30N.

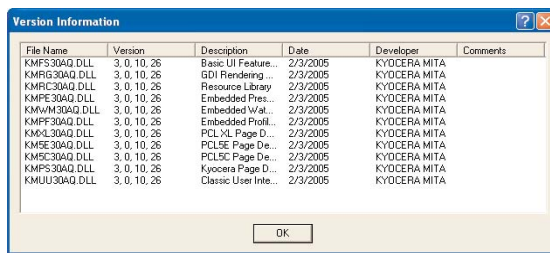
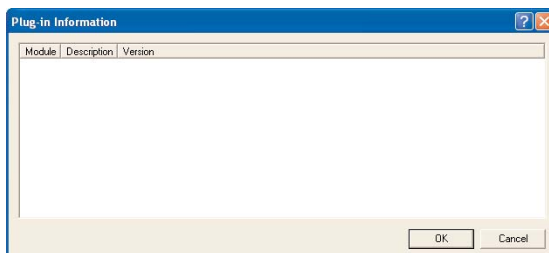



This page intentionally blank

Print System Utilities

The latest Drivers and Utilities are also available on the internet at

Operating System	Software Name	Description
Windows	PCL Print Drivers	Kyocera PCL drivers allow for font scaling, outline fonts, and vector graphic printing
	KPDL Print Driver	Adobe PostScript 3 language compatible
Driver Tools	KM Driver Deleter	Deletes installed printer with associated dependent files and registry entries
	Optional Printer Components	Allows installation of: Common Profiles, ICM Profiles, Localized Help Modules, or TrueType Fonts based on the driver installed.
Printer Utilities	KM-NET for Client (replaces KM-NET Remote Op Panel & KM-NET Job Mgr)	Manages print jobs on a local or network port using IP or IPX language protocols. Offers access to print settings commonly associated with front panel operations
	KM-NET Printer Disk Manager	Helps administrator/print jobs from the printer's hard disk.
	KM-NET Viewer	Remotely monitors printers on the network
	ICLink for Windows	Writes data to an external storage device. (Compact Flash Card)
Networking	KPrint	Creates printing port for printing via e-mail. Only available for KM printers/copiers with an IB-21E/22 interface card.
	KM-NET Viewer	allows advanced grouping, filtering, and sorting of KM and other printers.
	KM-NET Viewer Web Edition	Creates a centralised management system easily accessible to end users through a web browser
	Novell NDPS Gateway	Implements the Novell Distributed Printing Services gateway needed for NDPS support of Kyocera printers
Other	Online Documentation	Software Library Guide: Introduction, Driver Emulation, Install Drivers, Driver Tools, Printer Utilities, Networking, Installation Notes, Languages, and Mac Support
	KM-Net for Accounting	Remotely manages user account codes for Kyocera Devices. Tracks Prints by user account.
	PostScript Printer Description (PPD) files	Installed in the Printer Descriptions folder in the System folder
MAC	PostScript Printer Description (PPD) files	Text files describing printer features, options and settings. Installer places files in Libraries/Printers/PPDs/Contents/Resources/. Once installed, select within Print Center for complete printer support
	ColorSync profiles	Creates best quality color for Kyocera color devices. Profiles are stored in /Library/ColorSync/Profiles/.
	TrueType Screen Fonts	Displays fonts on screen to match resident printer fonts. AGFA or Bitstream are available. Fonts installed in /Library/Fonts.
	Online Documents	Supplements paper documentation supplied with printer.

Print System Utilities

Kyocera Digital Library CD-ROM

The Kyocera Mita Digital Library offers the most current printer drivers, software utilities and reference manuals. The Library CD contains the following components:

- ◆ Install Drivers
- ◆ Driver Tools
- ◆ Printer Utilities
- ◆ Networking
- ◆ Installation Notes
- ◆ Select Language

The latest Drivers and Utilities are also available on the internet at www.kyoceramita.com.au

Driver Emulations

Kyocera printer drivers support PCL and KPDL emulations. PCL, or Printer Command Language was developed by Hewlett Packard® (HP) to provide a simple and effective method for controlling a printer. In this language, the printer commands appear as embedded escape sequence codes in the print job data interpreted by the printer. Kyocera PCL drivers allow for font scaling, outline fonts, and vector graphic printing. PCL is not supported on Macintosh and UNIX based systems. Note: The factory default emulation for Kyocera printers is PCL. If the selected printer driver does not match the printer emulation, the printer emulation must be set for PCL, KPDL or KPDL (Auto) at the printer's front panel.

PCL 5c

Kyocera colour drivers utilize the PCL 5c colour printer language. This printer command language supports the commands necessary for colour printing, and supports PJP (Printer Job Language) commands, which allow for bi-directional communication between the printer and the computer. PCL 5c also provides complete backwards driver compatibility with earlier PCL versions, and offers a wide selection of fonts for use with Microsoft Windows applications.

PCL XL

Kyocera XL printer drivers utilize the PCL 6 printer language. PCL XL drivers offer improved graphics printing, reduced file sizes, better print speeds, and faster return to application than the PCL 5e driver. Drawbacks include no backwards compatibility and the fact that not all Kyocera printer models support XL printer drivers.

KPDL

Kyocera Page Description Language (KPDL) represents Kyocera's emulation of PostScript printing. Because the printer is set to a factory default of PCL, you must change the emulation from the printer's control panel or send the printer a command. PostScript print drivers have strong graphics reproduction performance and usually print slower than PCL drivers.

Print System Utilities

Driver Tools

Kyocera Driver Deleter

The Kyocera Driver Deleter Utility quickly removes a Printer Driver, its corresponding files, and Registry entries from a Windows based PC. It runs directly from the CD and displays a simple tree view of all installed printers on the system, the printer's files, registry entries, orphaned files, and OEM files. To uninstall, select the desired driver from the Printers section in the registry tree then press the Delete Key. The Uninstaller can remove one, or multiple printers from a system at the same time.

Install Optional Printer Components

This utility allows the installation of additional components such as Common Profiles, ICM Profiles, Localized Help Modules, or TrueType Fonts based on the driver installed.

Printer Utilities

KM-NET Printer Disk Manager

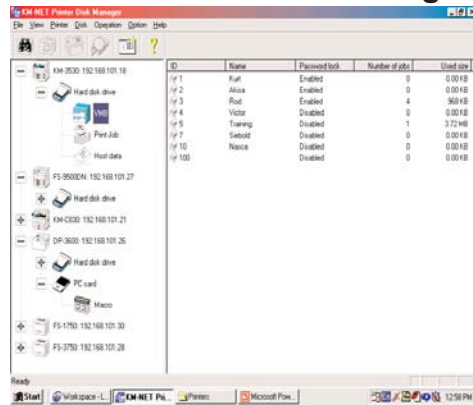

This Utility manages the Job Storage features available when using an optional Hard Disk or a RAM Disk. From a desktop computer, the Printer Disk Manager monitors and manages the Virtual Mailboxes and Job List items on these storage devices.

The Printer Disk Manager may also be used to monitor, access, and manage other optional printer data storage devices, such as a Memory Card, Compact Flash, or a MicroDrive.

Printer Disk Manager can be used with multiple printers connected locally (LPT, COM) and over a network (TCP/IP, IPX).

To ensure proper security, the Printer Disk Manager requires an Administrator Password to operate after installation. An Administrator Password must be defined during the software installation process, but may later be modified within the Utility.



Print System Utilities

IC Link for Windows

The IC Link Utility assembles and organizes all of the necessary components to create an IC Card project (PCMCIA/JEIDA, standard 4.0). Once assembled, the utility formats the components and transfers them onto an IC Card inserted into a locally connected printer. The IC Card contains the project information that will be read into printer memory upon power-up. The removable IC Card can be moved from one printer to another.

The IC Card project components include:

- ◆ Font data (TrueType, KPD, etc.)
- ◆ Host data (forms, logos, signatures)
- ◆ Macros, Program data (PRESCRIBE, PCL, KPD)
- ◆ Message data (to change the printer's Message Language setting).

The IC Link Utility enables you to download data directly to the printer's optional Hard Disk and EPROM (Erasable Programmable Read Only Memory). Data on these alternative storage devices can be managed in the same manner as the IC Cards, with the exception of Message data, which cannot be transferred.

IC Link for Windows can import DOS-based IC Link projects and manage, edit and delete information on previously used IC Cards. However, IC Link projects cannot be opened in DOS-based IC Link.

IC Link Benefits:

1. Facilitates the upgrade of firmware by managing new data the distribution.
2. Converts graphic information to PRESCRIBE Macro format for electronic forms management
3. Distributes MACRO information to a resident storage device on the Printer.

Print System Utilities

KM-NET Client

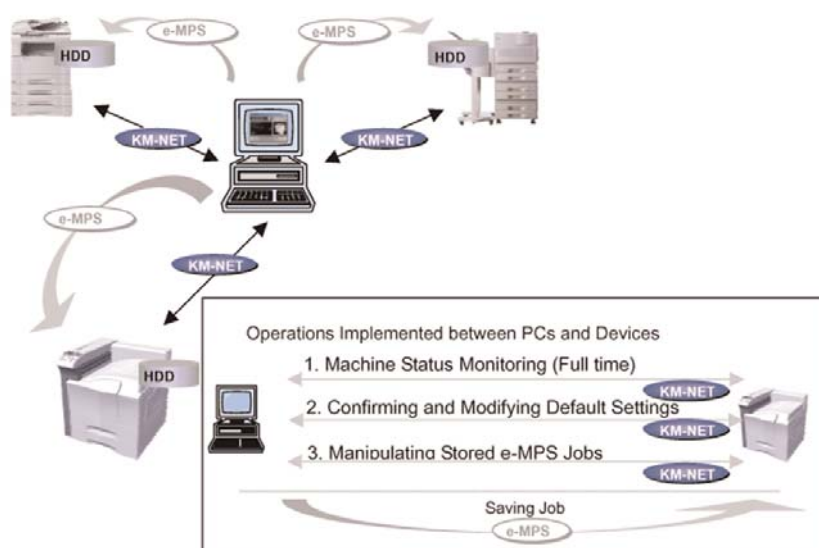

This network printing Utility is intended for end users who want to monitor and configure their print system and maintain e-MPS jobs stored on the Hard Disk Drive. Functionality includes:

- Full-time Machine Status Monitoring Information on Cassettes, Options and Errors
- Confirm and Modify Current Settings (equivalent to KM-NET Remote Operation Panel)
- Manipulating Stored e-MPS Jobs (equivalent to KM-NET Job Manager)
Temporary and Permanent Stored Jobs can be listed, printed, and deleted. In addition, users can modify the following job attributes: number of prints, output destination, and finishing including stapling and punching.

Print System Utilities

Network Utilities

KPrint

KPrint creates a printing port enabling printing via eMail. KPrint is only available for Kyocera Mita printers and digital copiers with an IB-21E/22 interface card. Using KPrint, a print job can be e-mailed to a remote printer over the Internet, using the standard print function in any Windows application. KPrint also provides LPR and IPP printing capabilities in Windows 95/98/Me (since LPR and IPP are not built-in to these versions of Windows).

KM-NET Viewer

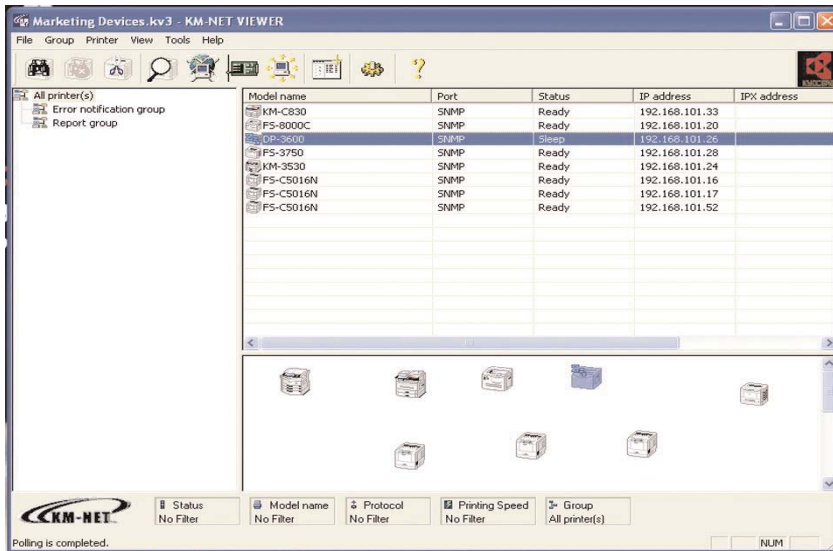

The KM-NET Viewer Utility allows Network Administrators to easily map and monitor network printers and change default settings with desktop convenience and ease of use. KM-NET Viewer can be enabled to send eMail, and sound messages for printer error notification.

Designed for Network Administrators, KM-NET Viewer is installed on a local workstation* and polls all network printers to determine current status. KM-NET Viewer can support thousands of devices.

Print System Utilities

KM-NET Viewer Web Edition

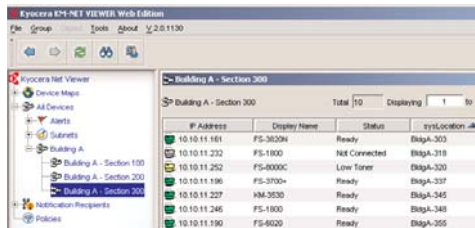

The KM-Net Viewer Web Edition* is browser based and designed for multiple end users. When KM-NET Viewer Web is installed on a server, it creates a centralised management system accessed through a web browser. It allows users to monitor network printers and change printer default settings.

Web KM-NET Viewer Web polls status information for all network printers from one centralized location. With a centralised management system for multiple users, polling overloads are averted since the polling source is reduced to one. Additionally, a central management system eliminates confusion caused by changing printer settings on multiple independent KM-NET Viewers.

Requirements:

Linux: Red Hat Enterprise Linux ES 3.0, Red Hat Enterprise Linux AS 3.0, Red Hat Enterprise Linux WS 3.0, Red Hat Desktop 9.0, SUSE Linux Enterprise Server 9, SUSE Linux Professional 9.1.

Windows: Windows 2003 Server, Windows XP Professional, Windows 2000 Server, Windows 2000 Professional

The client requires a Java enabled browser with the JRE plug-in 1.4.2_x. Virtually all current browsers are Java enabled. The JRE plug-in can be downloaded from <http://java.sun.com/j2se/1.4.2/download.html> if not already installed. The following browsers are officially supported by KMNW Web 2.0:

Internet Explorer 6 or higher, Netscape 7.2 or higher, Mozilla 1.7 or higher

Novell NDPS Gateway

Novell Distributed Print Services (NDPS) is a printing architecture for NetWare 5.x and 6.x environments that provides enhanced printing functionality and improved printer administration which were not available in the previous queue management system printing model. The Kyocera Mita NDPS Gateway provides NDPS connectivity for Kyocera Mita printer models allowing users to take advantage of enhanced NDPS printing and management functions.

The Kyocera Mita NDPS Gateway provides the following NDPS features:

- ◆ Plug and Print
- ◆ Automatic Driver Download
- ◆ Public Access and Controlled Access Printing Support
- ◆ IP and IPX Printing Support
- ◆ Printer Agent Configuration Via Server Console and NWAdmin
- ◆ Detailed Printer Status Monitoring Including Printer Configuration and
- ◆ Front Panel Display in NWAdmin
- ◆ Detect Error Conditions and Generate Messages to Users and/or Admins

*Requirements: A network server operating on Novell NetWare, version 4.11 and higher. 562 KB per PA (Printer Agent). Minimum of 5.8 MB available hard disk space.

Print System Utilities

PDF Direct Print Utility

PDF Direct Print is standard on the FS-C5020N and the FS-C5030N allowing PDF eMail attachments to be printed without having to detach and open the file. PDF Direct Print allows any PDF file to be printed simply by choosing the file within the KM-NET Direct Print Dialog Box. In addition, users can choose the Number of Copies, Collate, Layout (Fit to Page, Booklet, Catalogue), N-Up, Paper Size, Single or Double Sided, Resolution, and EcoPrint.

Life Counters

Users can access the Total Print Counter under the Colour Mode Menu - Life Counters, or by printing the Status Page. Cyan, Magenta, Yellow, and Black Toner Counter information can also be found under Life Counters.

Individual Toner Counters

The life of each toner cartridge is illustrated on the Status Page using a gauge ranging from 100 (indicated toner is full) down to 0. Having access to this data will enable users to pro-actively add toner when needed before starting a large print job.

Note: To ensure accuracy of each meter, a simple procedure must be followed. If the Operation Panel shows "Low Toner" and the toner is replaced, the user must reset the colour meter for that toner through the Operation Panel. If the user continues to use the Printer when the toner level is low, the Printer will stop printing when the toner is depleted and "Replace Toner" will display on the Operation Panel. When the toner is replaced after receiving this message, the meter is automatically reset without user intervention.

Counters, Yields, and Volume Rating

Consumable Yields

The FS-C5020N and the FS-C5030N have one of the most aggressive TCOs of any Colour Laser Printer in the industry. This is attributed in part to the yields of the Consumables and Maintenance Kits listed below.

Toner Yields*

Yellow Toner Kit (TK-510Y)	8,000 Pages
Cyan Toner Kit (TK-510C)	8,000 Pages
Magenta Toner Kit (TK-510M)	8,000 Pages
Black Toner Kit (TK-510K)	8,000 Pages

Maintenance Kits

FS-C5020N: Maintenance Kit (MK-510)	200,000 Images
FS-C5030N: Maintenance Kit (MK-520)	200,000 Images

**ships with 4K each for C, M, Y, and K*



Volume Ratings

The FS-C5020N and FS-C5030N have one of the highest Maximum Monthly Volume ratings of any Printer in its price class. For Full-Colour and Monochrome output, the FS-C5020N is rated at 85,000, while the FS-C5030N is rated at up to 100,000 pages per month!

Summary

Good things come in small packages, and the FS-C5020N and the FS-C5030N are no exception. In fact, just like their predecessor the FS-C5016N, they are exceptional, with its low cost per print, convenient KX Driver, KX Utilities, and other options including Wireless Networking, these 16 and 24ppm Full-Colour and Monochrome Printers are the perfect addition to any corporate environment requiring A4 sized output.

For more information on the FS-C5020N and the FS-C5030N, log on to www.kyoceramita.com.au



This page intentionally left blank.

Trademarks and Disclaimers

Microsoft is a registered Trademark of Microsoft Corporation. Windows and Windows NT are trademarks of Microsoft Corporation. Novell, NetWare, and UNIX are registered trademarks of Novell Inc. Postscript is a registered trademark of Adobe Systems Inc. Adobe, Adobe Illustrator, Adobe Photoshop, PageMaker are trademarks of Adobe Systems Inc.

All other products or services identified throughout this Product Guide are trademarks or registered trademarks of their respective companies. They are used throughout this book in editorial fashion only and for the benefit of such company. No such use, or the use of any trade name, is intended to convey endorsement or other affiliation with this product Guide.

NOTE: the information for this Product Guide was gathered from several sources, which we deem reliable and to the best of our knowledge are accurate. However, Kyocera shall not be responsible for any inaccuracies contained herein. This Product Guide is for the sole information of our valued dealers, resellers, joint ventures, and direct salesforce. It is not to be reprinted, or used by any other party.

©2005 Kyocera Mita America, Inc.

Reproduction of the information contained herein is prohibited by law.

Log on to www.kyoceramita.com.au for more information.



This page intentionally left blank.

Index

C

Counters, Yields, and Volume Ratings .47
 Consumable Yields .47
 Maintenance Kits .47
 Toner Yields .47
 Life Counters .46
 Toner Counters .46
 Volume Ratings .47

F

features .7
 FS-C5020/30N Controller .27
 Print Controller .27
 Standard Interfaces .10
 Status Page .27
 FS-C5020/30N Productivity .21
 Electronic Sort .21
 e-MPS .21
 Job Storage .21
 Private Print .21
 Proof and Hold .21
 Quick Copy .21
 Virtual Mailboxes .21
 Remote Maintenance System Solution .22
 Standard PDF Direct Printing .22
 Total Counts System Solution .22
 FS-C5020/30N Technology .19
 Automatic Color Calibration .20
 Color Control .20
 Color Matching .20
 Environment Adoption Stabilisation System (EASS) .20
 Kyocera Fine Color Technology (FCT) .19
 Advanced Beam Array .19
 Belt Transfer .19
 Touch Down Development .19
 Kyocera Intelligent Color Technology (ICT) .20
 High Speed Image Processing .20
 High-Image Quality .20
 High-Speed Data Processing .20
 Multi-Bit Technology .19
 Oil-Less Fusing .20
 Speed .21

I

Introduction .5

K

Key Features .13
 Fast Printing .13
 Hard Disk Drive Storage .14
 Multiple Interfaces Mean Flexibility .16
 Multi-Purpose Tray (MPT) .16
 Small Footprint .13
 Standard Connectivity .14
 Throughput Capabilities .16
 Variable Gloss .14

KX Driver .29

 Color Tab .32
 Imaging Tab .31
 Job Settings .35
 Layout Tab .30
 Media Tab .29
 Output Tab .35
 ProfileTab .37
 Prologue/Epilogue Tab .35
 Watermark Tab .36

O

Optional Accessories .23
 Automatic Duplex Unit (DU-301) .23
 Compact Flash Memory Slot .24
 Configurations .23
 Envelope Feeder (EF-60) .23
 Expansion Memory .24
 Hard Disk Drive .24
 Network Interface Cards .25
 Paper Drawers (PF-60) .23

P

Print System Utilities .39
 Driver Emulations .40
 KPDL .40
 PCL 5c .40
 PCL XL .40
 Driver Tools .41
 Install Optional Printer Components .41
 Kyocera Driver Deleter .41
 KM-NET PDF Direct Print Utility .46
 Kyocera Digital Library CD-ROM .40
 Network Utilities .44
 Advanced Setup .44
 KM-NET Viewer .44
 KM-NET Viewer Web Edition .45
 KPrint .44
 Kyocera NDPS Gateway .45
 Printer Utilities .41
 IC Link for Windows .43
 KM-NET Client .42
 KM-NET Printer Disk Manager .42

S

Summary .47
 System Overview .6

T

Trademarks and Disclaimers .49